

**SITS**  
— *comfortable life*



---

cocktail  
& design

ALEX

## ARMCHAIR

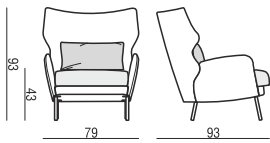

## 2,5 SEATER

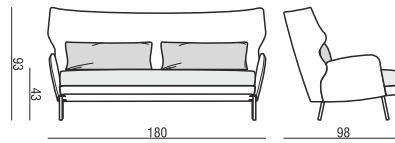

## FOOTSTOOL

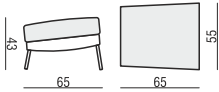

## FOOTSTOOL ROUND

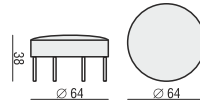

## HEADREST

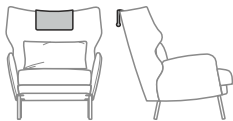

## ARMREST PROTECTION



## UPHOLSTERY

FABRIC or LEATHER: FC - fix cover

## FEET

No. 160 metal chrome, painted black or grey and brushed steel\*  
FRONT: ARMCHAIR, FOOTSTOOL, SOFA

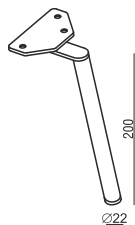

No. 160A metal chrome, painted black or grey and brushed steel\*  
BACK: ARMCHAIR, FOOTSTOOL

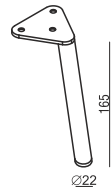

No. 160C metal chrome, painted black or grey and brushed steel\*  
FOOTSTOOL ROUND



No. 160D metal chrome, painted black or grey and brushed steel\*  
BACK: SOFA

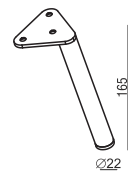

\*please check a cost of brushed steel finish with a sale representative

## STANDARD COMFORT

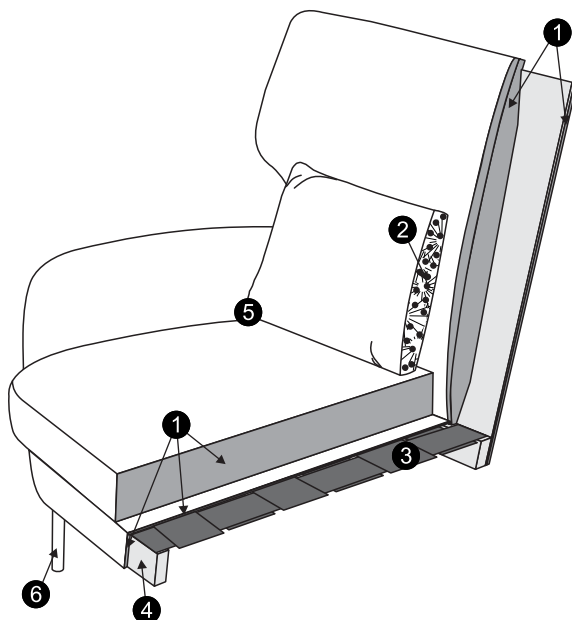

1. polyurethane foam/high resilient polyurethane foam
2. silicone balls
3. upholstery belts
4. FSC® certified solid wood and wood based elements
5. fabric or leather
6. painted metal, chrom or brushed legs