

LENA

SITS reserves the right to change construction of products and components used due to improving durability of product and customer satisfaction without any further notice. Explicit ±2 cm tolerance of all elements sizes.

www.sits.eu
JANUARY 2018

ARMCHAIR

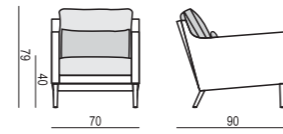

VERSION A
2 SEATER

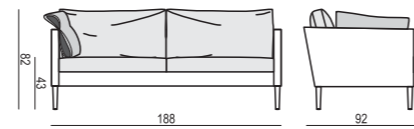

2 SEATER LEFT (or RIGHT)

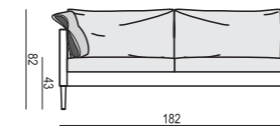

2 SEATER without ARMRESTS

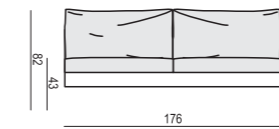

2 SEATER DEEP

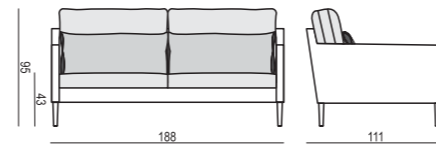

2 SEATER DEEP LEFT (or RIGHT)

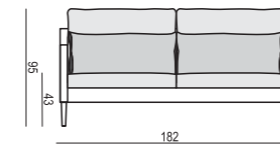

2 SEATER DEEP without ARMRESTS

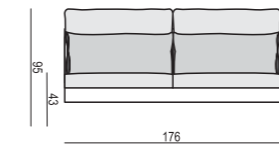

3 SEATER

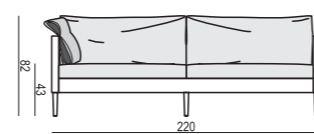

3 SEATER LEFT (or RIGHT)

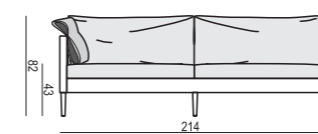

3 SEATER without ARMRESTS

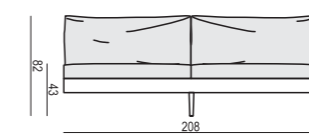

3 SEATER DEEP

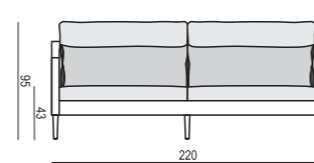

3 SEATER DEEP LEFT (or RIGHT)

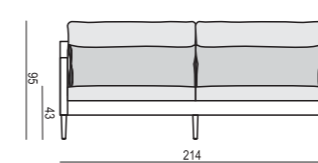

3 SEATER DEEP without ARMRESTS

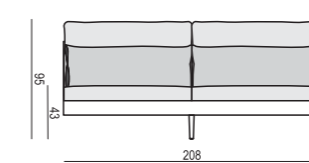

ELEMENT LEFT (or RIGHT)

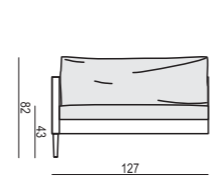

ELEMENT without ARMRESTS

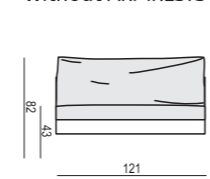

ELEMENT DEEP LEFT (or RIGHT)

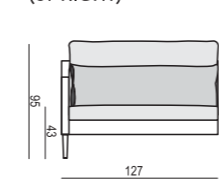

ELEMENT DEEP without ARMRESTS

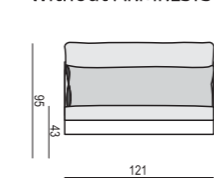

CHAISELONGUE WIDE LEFT (or RIGHT)

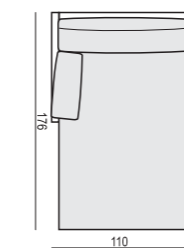

CHAISELONGUE WIDE DEEP LEFT (or RIGHT)

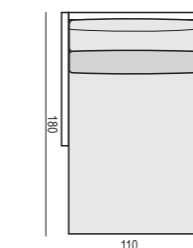

VERSION C
2 SEATER

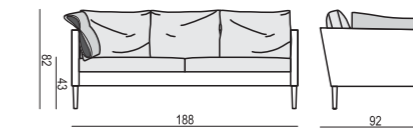

2 SEATER LEFT (or RIGHT)

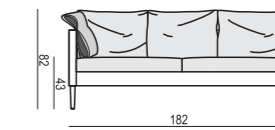

2 SEATER without ARMRESTS

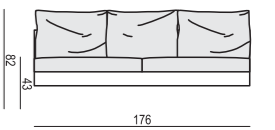

2 SEATER DEEP

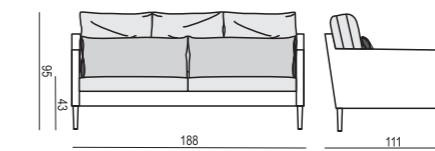

2 SEATER DEEP LEFT (or RIGHT)

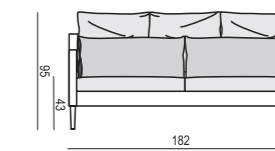

2 SEATER DEEP without ARMRESTS

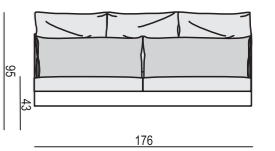

3 SEATER

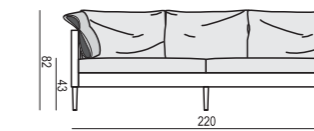

3 SEATER LEFT (or RIGHT)

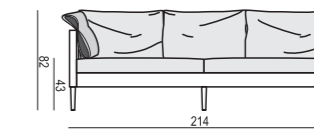

3 SEATER without ARMRESTS

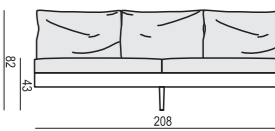

3 SEATER DEEP

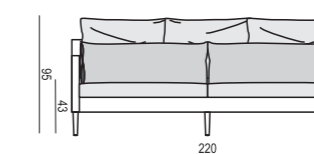

3 SEATER DEEP LEFT (or RIGHT)

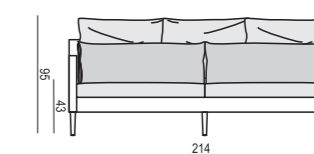

3 SEATER DEEP without ARMRESTS

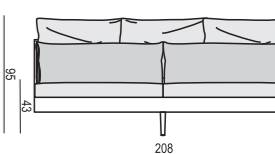

ELEMENT LEFT (or RIGHT)

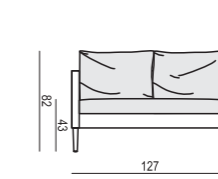

ELEMENT without ARMRESTS

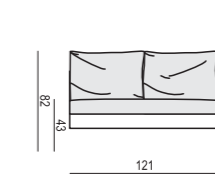

ELEMENT DEEP LEFT (or RIGHT)

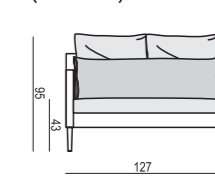

ELEMENT DEEP without ARMRESTS

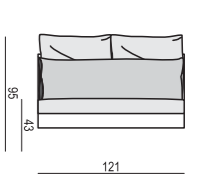

CHAISELONGUE WIDE LEFT (or RIGHT)

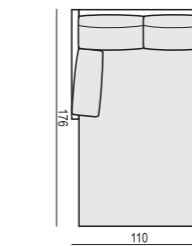

CHAISELONGUE WIDE DEEP LEFT (or RIGHT)

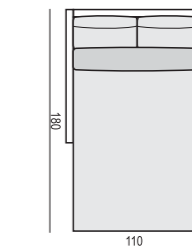

LENA

tea
& book

DIVAN (TWO PARTS) LEFT (or RIGHT)

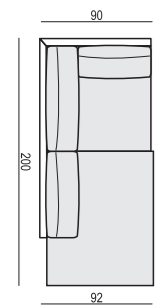

CHAISELONGUE LEFT (or RIGHT)

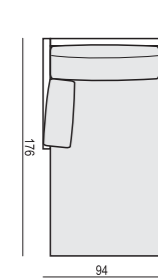

CORNER 90°

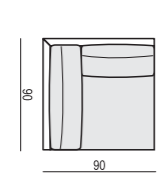

BENCH LEFT (or RIGHT)

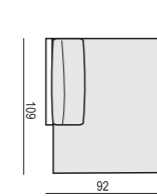

DIVAN DEEP (TWO PARTS) LEFT (or RIGHT)

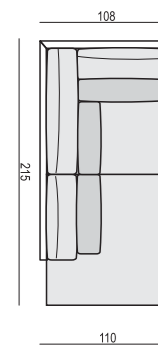

CORNER DEEP 90°

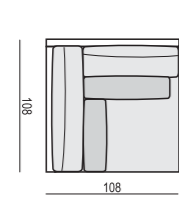

BENCH DEEP LEFT (or RIGHT)

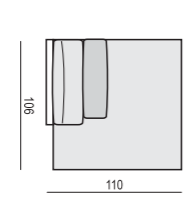

FOOTSTOOL 58x40 (for ARMCHAIR)

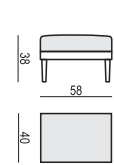

FOOTSTOOL 120x50

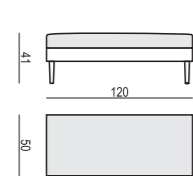

FOOTSTOOL 110x90

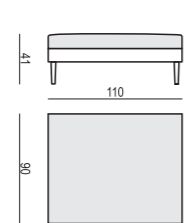

ACCESSORIES

LOW BACK CUSHION

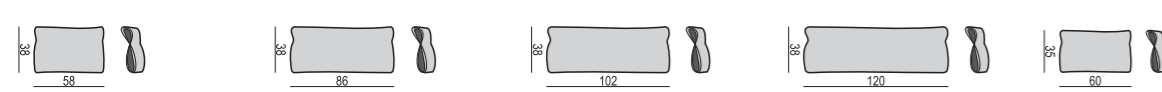

DIVAN CORNER BENCH 2 SEATER 3 SEATER CHAISELONGUE ELEMENT ARMCHAIR

CUSHIONS

Only cushions in SOFAS

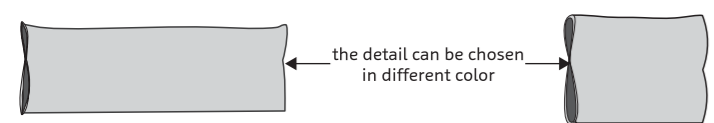

LOW BACK CUSHION element deep

ARMRESTS CUSHION

SITS reserves the right to change construction of products and components used due to improving durability of product and customer satisfaction without any further notice. Explicit ±2 cm tolerance of all elements sizes.

VERSION A

SET 1

ELEMENT LEFT + ELEMENT RIGHT

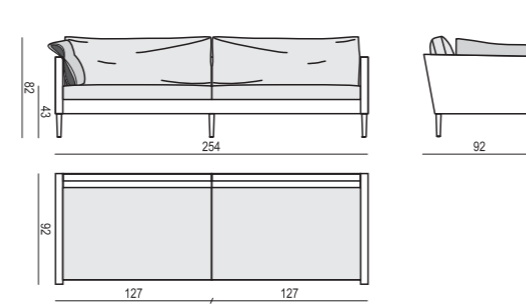

SET 2

ELEMENT DEEP LEFT + ELEMENT DEEP RIGHT

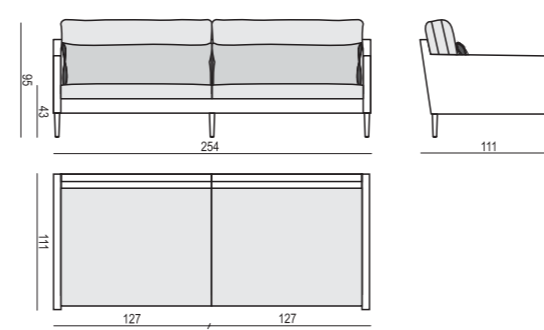

VERSION C

SET 1

ELEMENT LEFT + ELEMENT RIGHT

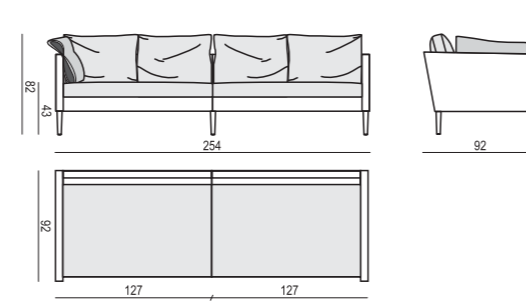

SET 2

ELEMENT DEEP LEFT + ELEMENT DEEP RIGHT

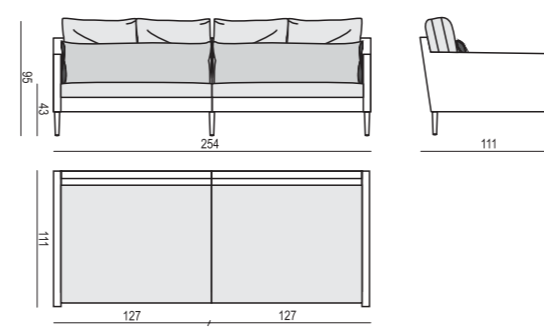

EXAMPLE OF SETS:

Option for connecting ELEMENTS

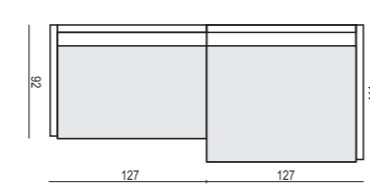

SET: CHAISELONGUE LEFT (or RIGHT) + CHAISELONGUE RIGHT (or LEFT)

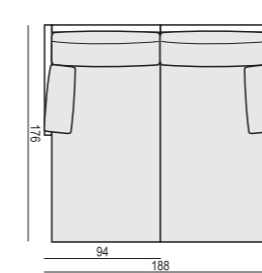

SET: 3 SEATER DEEP LEFT (or RIGHT) + CORNER DEEP 90° + BENCH DEEP RIGHT (or LEFT)

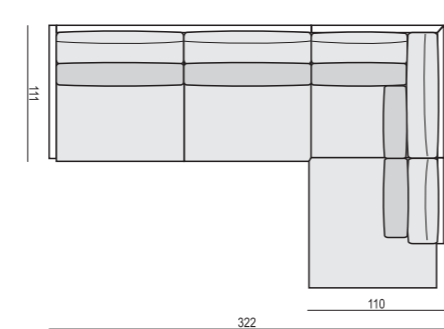

SITS reserves the right to change construction of products and components used due to improving durability of product and customer satisfaction without any further notice. Explicit ±2 cm tolerance of all elements sizes.

UPHOLSTERY

FABRIC: FC - fix cover or LC - loose cover

FEET

METAL FEET FOR:

SOFA, FOOTSTOOL 120x50, FOOTSTOOL 110x90, CHAISELONGUE, DIVAN, CORNER 90°, FOOTSTOOL 58x40, BENCH: 162; ARMCHAIR: FRONT 150B, BACK 160A.

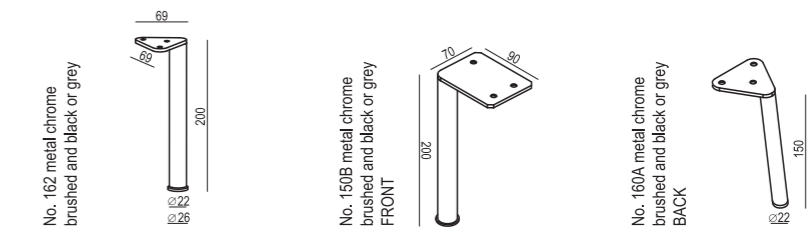

WOODEN FEET FOR:

SOFA, FOOTSTOOL 120x50, FOOTSTOOL 110x90, CHAISELONGUE, DIVAN, CORNER 90°, BENCH: 161; FOOTSTOOL 58x40: 163; ARMCHAIR: FRONT 163, BACK 163A.

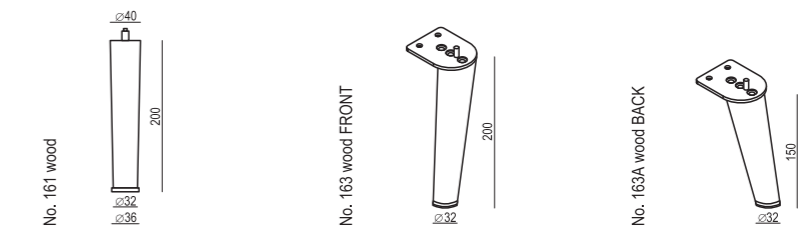

STANDARD COMFORT

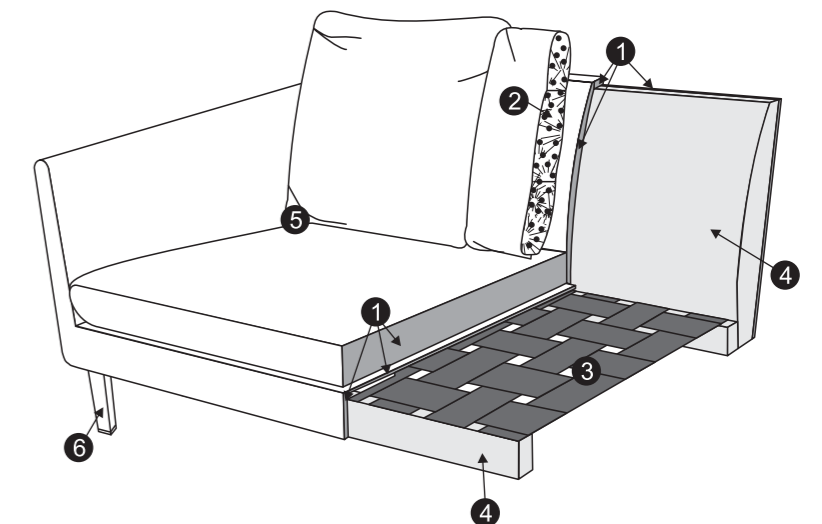

1. polyurethane foam/high resilient polyurethane foam
2. cushion chamber with mix of feather and silicone balls
3. upholstery belts
4. FSC certified solid wood frame
5. fabric
6. FSC certified solid wood or metal legs