

ARMCHAIR

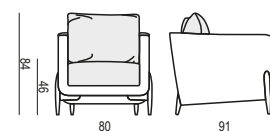

**VERSION A
ARMCHAIR WIDE**

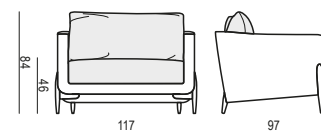

ARMCHAIR WIDE LEFT (or RIGHT)

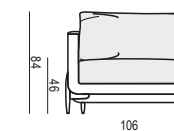

ARMCHAIR WIDE without ARMRESTS

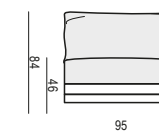

2 SEATER

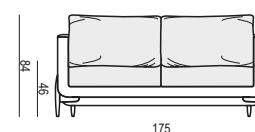

2 SEATER LEFT (or RIGHT)

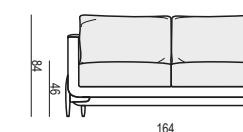

2 SEATER without ARMRESTS

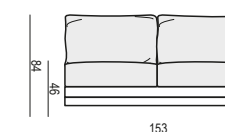

3 SEATER

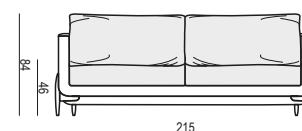

3 SEATER LEFT (or RIGHT)

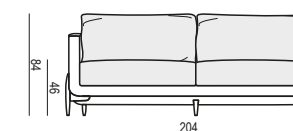

3 SEATER without ARMRESTS

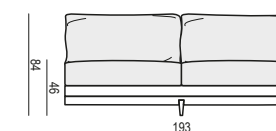

**VERSION C
ARMCHAIR WIDE**

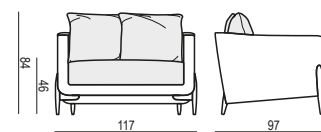

ARMCHAIR WIDE LEFT (or RIGHT)

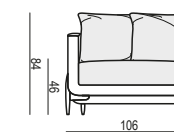

ARMCHAIR WIDE without ARMRESTS

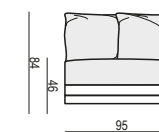

2 SEATER

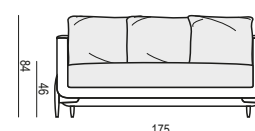

2 SEATER LEFT (or RIGHT)

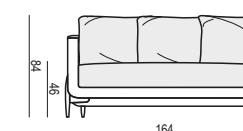

2 SEATER without ARMRESTS

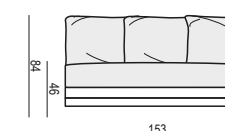

3 SEATER

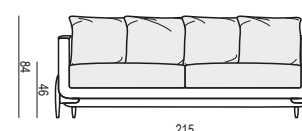

3 SEATER LEFT (or RIGHT)

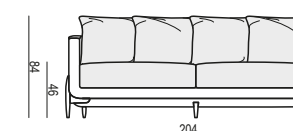

3 SEATER without ARMRESTS

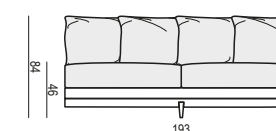

VERSION A

CHAISELONGUE LEFT (or RIGHT)

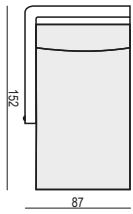

CHAISELONGUE WIDE LEFT (or RIGHT)

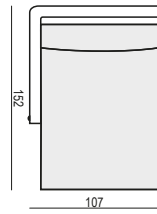

CORNER 90° ROUND

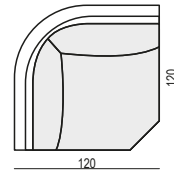

VERSION C

CHAISELONGUE LEFT (or RIGHT)

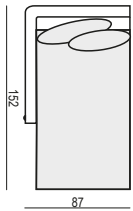

CHAISELONGUE WIDE LEFT (or RIGHT)

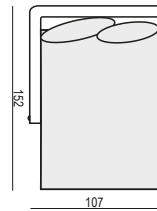

CORNER 90° ROUND

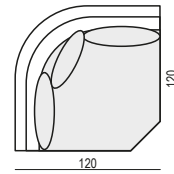

CHAISELONGUE FREESTANDING LEFT (or RIGHT)

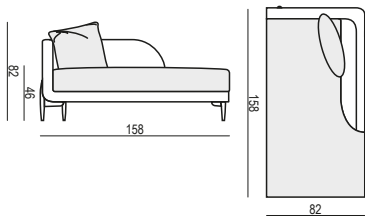

FOOTSTOOL 55x95

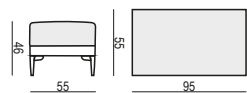

FOOTSTOOL 45x60

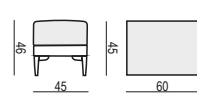

EXAMPLE OF SETS WITH BACK CUSHIONS COMBINATIONS

EXAMPLE 1

3 SEATER ver.A LEFT (or RIGHT) + CORNER 90° ROUND ver.C
+ 3 SEATER without ARMRESTS ver.A + CHAISELONGUE WIDE ver.C RIGHT (or LEFT)

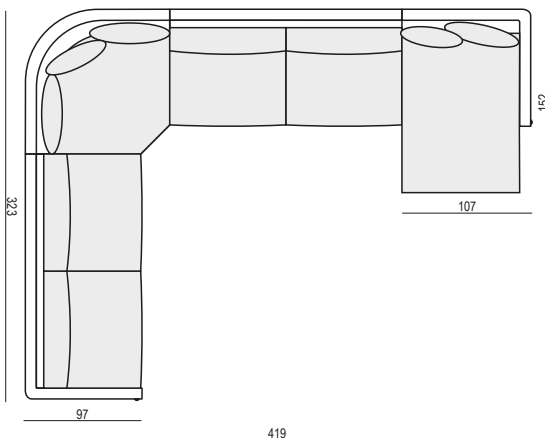

FEET

3 SEATER LEFT (or RIGHT): 1x no 159, 1x no 159a, 1x no 159d
CORNER 90° ROUND: 1x no 159, 3x no 159a
3 SEATER without ARMRESTS: 1x no 159d
CHAISELONGUE WIDE RIGHT (or LEFT): 2x no 159b, 1x no 159, 2x no 159a

EXAMPLE 2

CHAISELONGUE ver.C LEFT (or RIGHT)
+ 2 SEATER ver.A RIGHT (or LEFT)

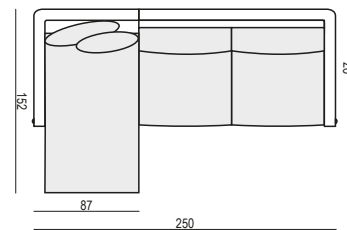

FEET

CHAISELONGUE RIGHT (or LEFT): 2x no 159b, 1x159, 2x159a
2 SEATER LEFT (or RIGHT): 1x no 159, 1x no 159a

SITS reserves the right to change construction of products and components used due to improving durability of product and customer satisfaction without any further notice. Explicit ±2 cm tolerance of all elements sizes.

UPHOLSTERY

FABRIC: FC - fix cover

FEET

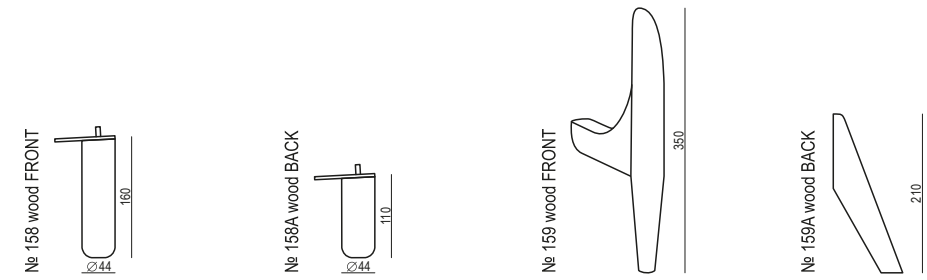

CHAISELONGUE

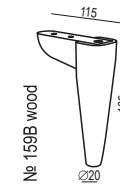

CORNER

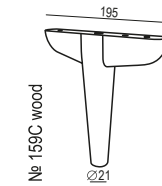

EXAMPLE

with feet
no. 159 and no. 159A

with feet
no. 158 and no. 158A

2 SEATER ver. A

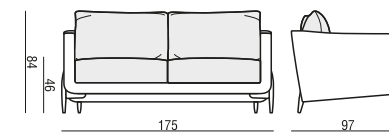

2 SEATER ver. A

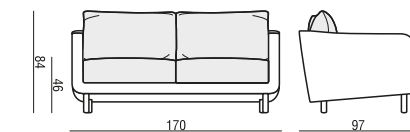

Important! The width of the sofas depends on the legs. The difference is 5 cm overall dimensions.

STANDARD COMFORT

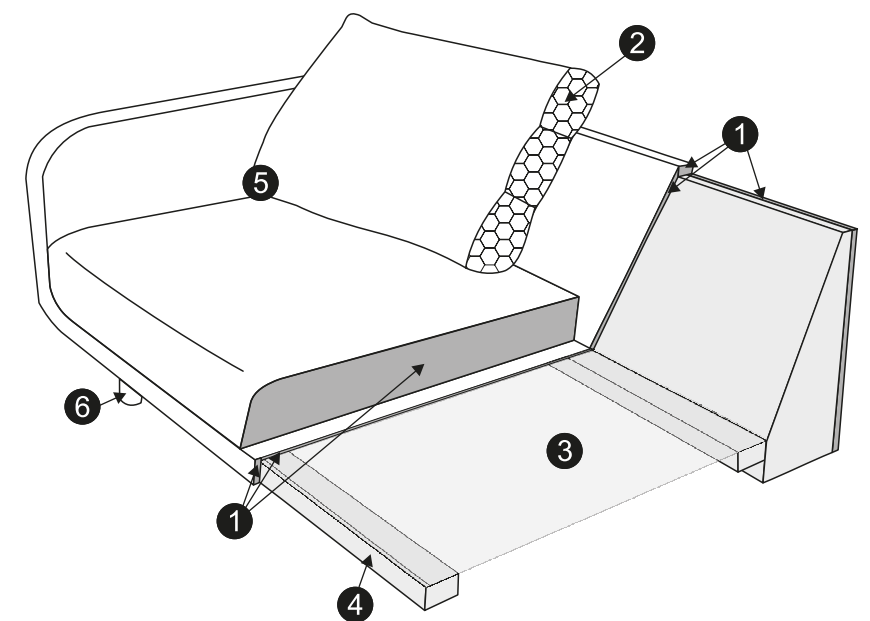

1. polyurethane foam/high resilient polyurethane foam
2. silicone balls
3. dynaflex - elastic fabric
4. solid wood and wood based elements
5. fabric
6. solid wood legs