

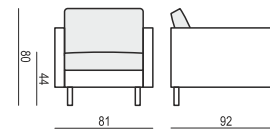

ARMCHAIR

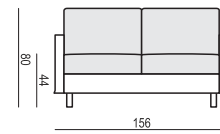

2 SEATER



2 SEATER LEFT (or RIGHT)

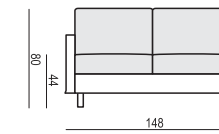

2 SEATER without ARMRESTS

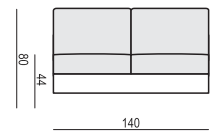

2,5 SEATER

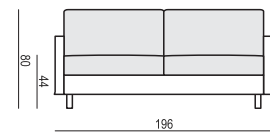

2,5 SEATER LEFT (or RIGHT)

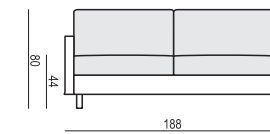

2,5 SEATER without ARMRESTS

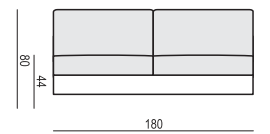

3 SEATER

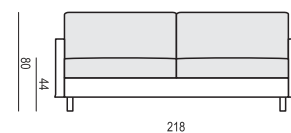

3 SEATER LEFT (or RIGHT)

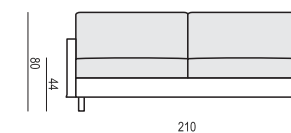

3 SEATER without ARMRESTS

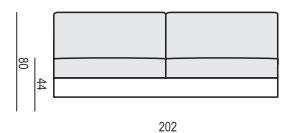

4 SEATER (TWO PARTS)

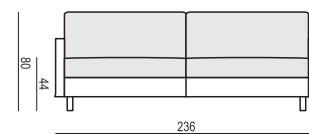

4 SEATER (TWO PARTS) LEFT (or RIGHT)

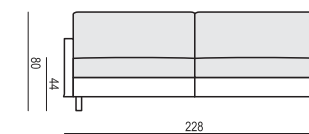

4 SEATER (TWO PARTS) without ARMRESTS

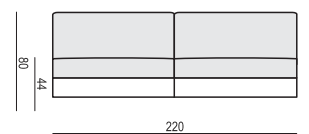

DIVAN LEFT (or RIGHT)

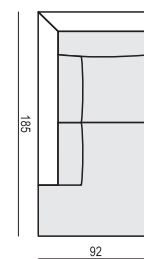

BENCH LEFT (or RIGHT)

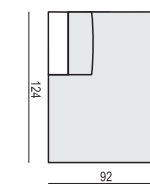

CORNER 90°

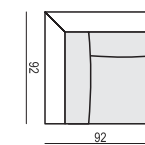

FOOTSTOOL

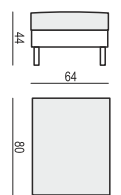

ARMREST I
cm 88 x 8 x 49 H

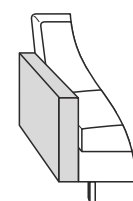

ARMREST II
cm 88 x 15 x 49 H

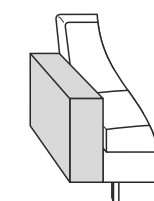

ENDPART LEFT (or RIGHT)
cm 88 x 2,5 x 49 H

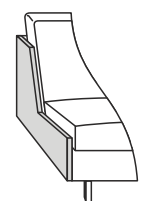

HEADREST with ROLL

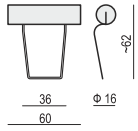

CUSHION

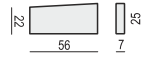

SET 4 LEFT (or RIGHT)

DIVAN LEFT (or RIGHT) + 2,5 SEATER RIGHT (or LEFT)

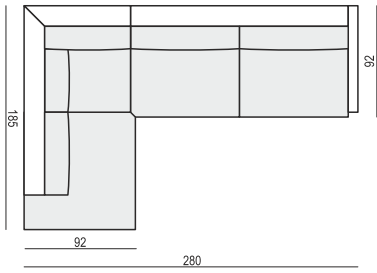

SET 5 LEFT (or RIGHT)

DIVAN LEFT (or RIGHT) + 2 SEATER RIGHT (or LEFT)

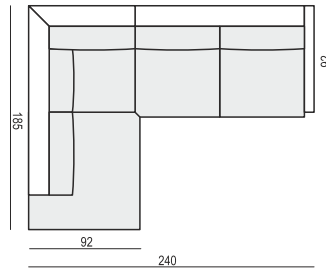

UPHOLSTERY

FABRIC: FC - fix cover or LC - loose cover and LEATHER: FC - fix cover

FEET

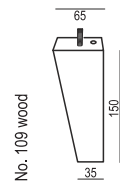

No. 109 wood

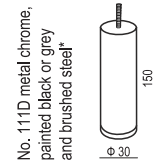

No. 111D metal chrome, painted black or grey and brushed steel

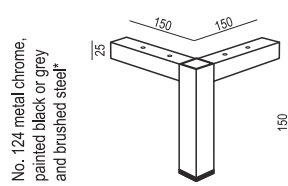

No. 124 metal chrome, painted black or grey and brushed steel*

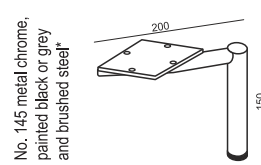

No. 145 metal chrome, painted black or grey and brushed steel*

*please check a cost of brushed steel finish with a sale representative

ALL LEGS CAN BE FIXED TO BOTH ARMRESTS:

under armrest

under frame

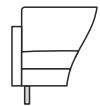
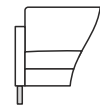

STANDARD COMFORT

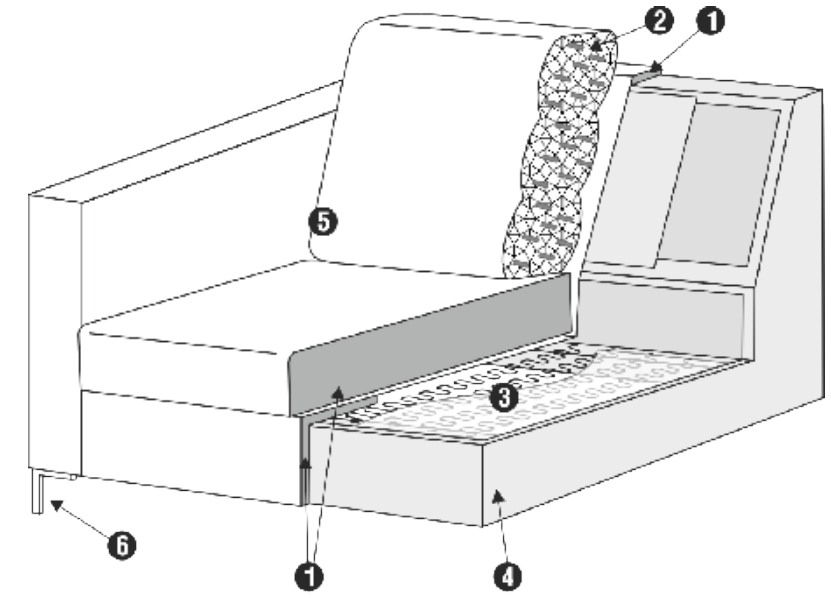

1. polyurethane foam/ high resilient polyurethane foam
2. foam flakes with silicone balls
3. springs
4. FSC certified solid wood and wood based elements
5. fabric or leather
6. FSC certified solid wood or metal legs

LUX COMFORT

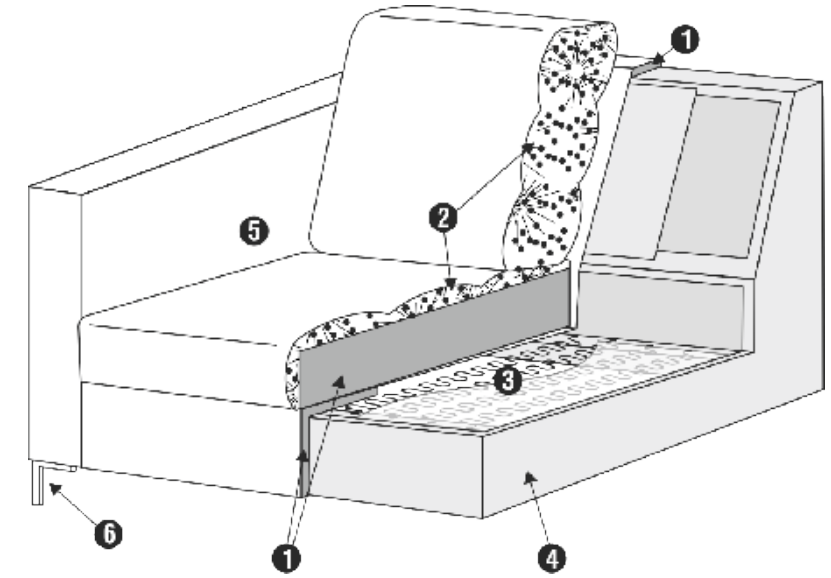

1. polyurethane foam/ high resilient polyurethane foam
2. cushion chamber with mix of feather and silicone balls
3. springs
4. FSC certified solid wood and wood based elements
5. fabric or leather
6. FSC certified solid wood or metal legs

PREMIUM COMFORT

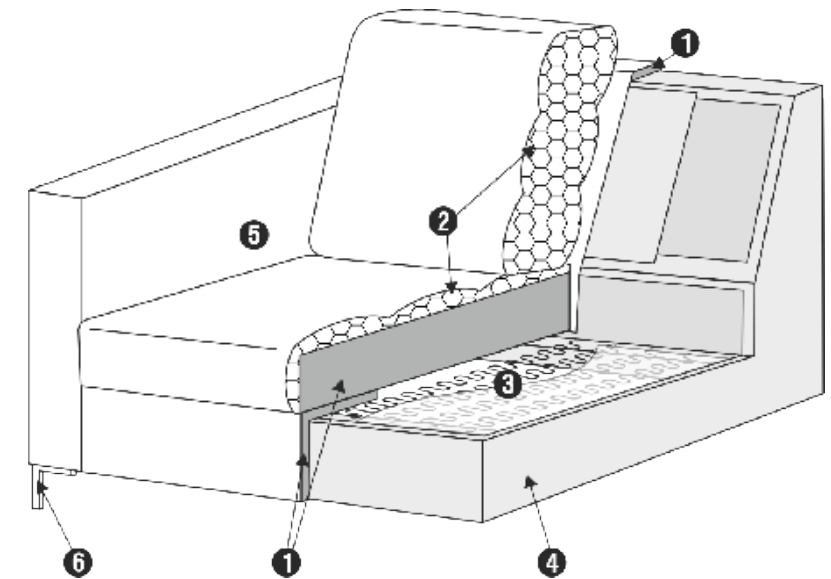

1. polyurethane foam/ high resilient polyurethane foam
2. silicone balls
3. springs
4. FSC certified solid wood and wood based elements
5. fabric or leather
6. FSC certified solid wood or metal legs