

**SITS**  
— *comfortable life*



---

cocktail  
& design

ELSA

## ARMCHAIR

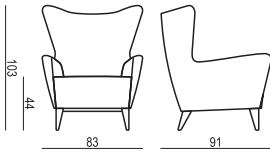

## ARMCHAIR with neckrest pillow

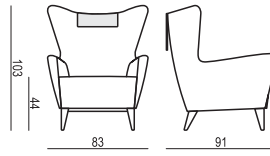

## FOOTSTOOL

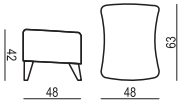

## NECKREST PILLOW

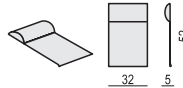

## ARMREST PROTECTION

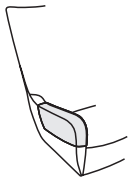

## UPHOLSTERY

**FABRIC: FC - fix cover** Limited choice of fabrics. Check with sales representative.

## FEET

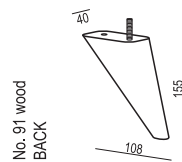
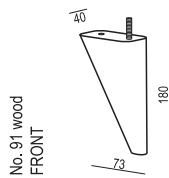

## STANDARD COMFORT

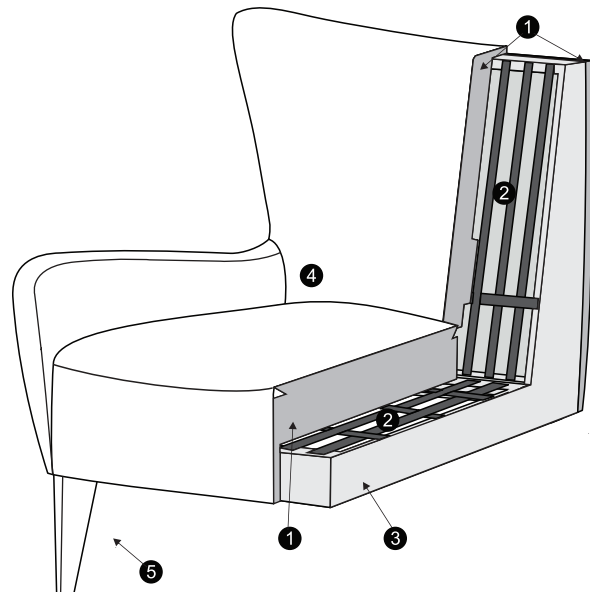

1. polyurethane foam/high resilient polyurethane foam
2. upholstery belts
3. FSC® certified solid wood and wood based elements
4. fabric (limited choice)
5. FSC® certified solid wood legs