

2 SEATER

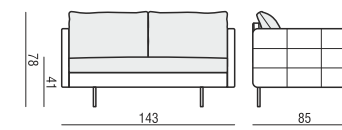

3 SEATER TWO PARTS

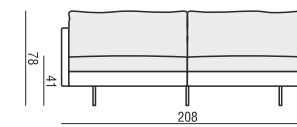

4 SEATER TWO PARTS with 3x BACK CUSHIONS

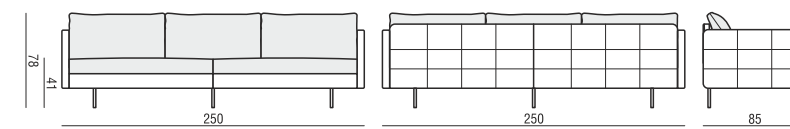

or

4 SEATER TWO PARTS with 2x BACK CUSHIONS

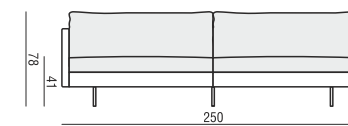

HEADREST

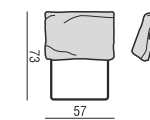

CUSHION 60x40

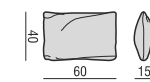

CUSHION 40x40

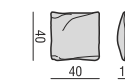

CUSHION 55x32

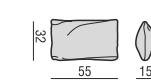

CUSHION 57x68

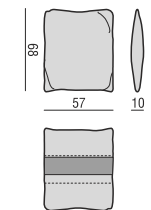

SET 1 LEFT (or RIGHT)
ELEMENT 104 LEFT (or RIGHT) + CORNER 90°
+ ELEMENT 125 RIGHT (or LEFT)

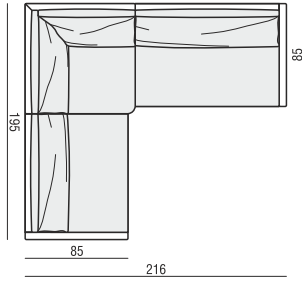

SET 2
ELEMENT 125 LEFT + CORNER 90°
+ ELEMENT 125 RIGHT

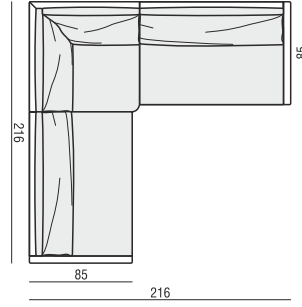

SET 3 LEFT (or RIGHT)
BENCH LEFT (or RIGHT) + CORNER 90°
+ ELEMENT 125 RIGHT (or LEFT)

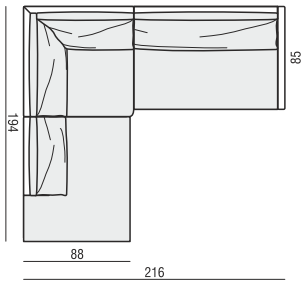

SITS reserves the right to change construction of products and components used due to improving durability of product and customer satisfaction without any further notice. Explicit ±2 cm tolerance of all elements sizes. Drawings show the high for standard comfort seats. Lux comfort seats are 2 cm higher.

UPHOLSTERY

FABRIC: FC - fix cover

FEET

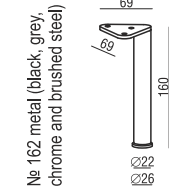

STANDARD COMFORT

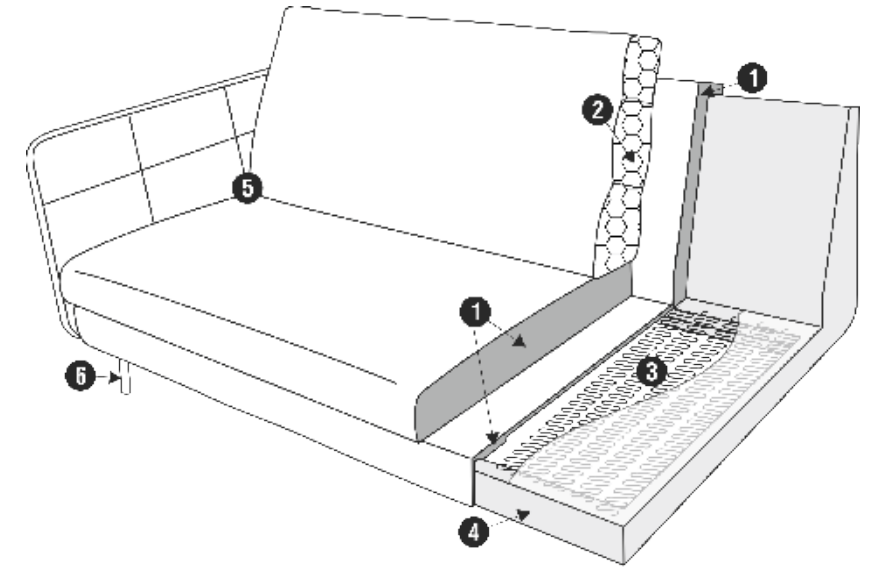

1. polyurethane foam/ high resilient polyurethane foam
2. silicone balls
3. springs
4. FSC® certified solid wood and wood based elements
5. fabric
6. metal legs

LUX COMFORT

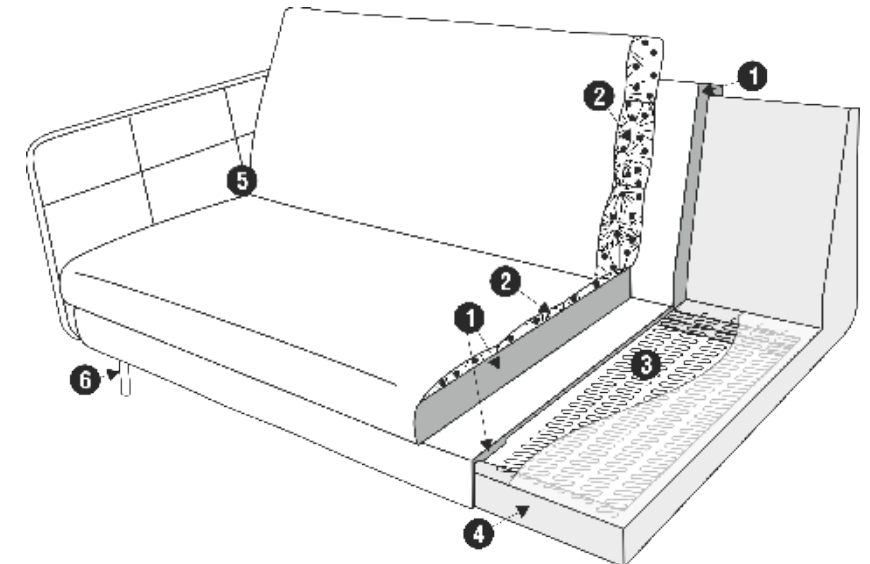

1. polyurethane foam/ high resilient polyurethane foam
2. cushion chamber with mix of feather and silicone balls
3. springs
4. FSC® certified solid wood and wood based elements
5. fabric
6. metal legs