

ARMCHAIR

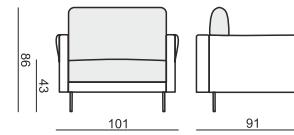

2 SEATER

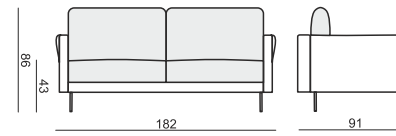

3 SEATER

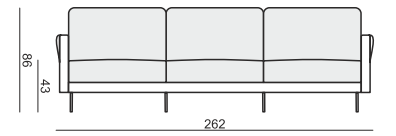

SEAT ELEMENT 80

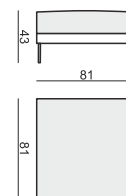

SEAT ELEMENT 160

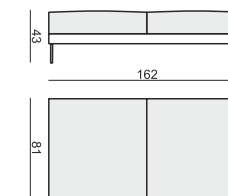

SEAT ELEMENT 240

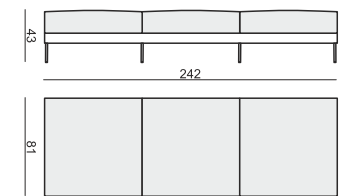

FOOTSTOOL

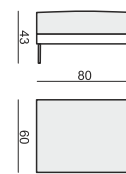

CUSHION 81x48



CUSHION 67x48

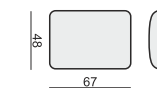

ARMREST / BACKREST available in loose cover

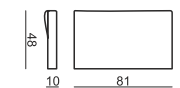

UNLIMITED POSSIBILITIES OF COMBINATIONS – BELOW EXAMPLE ARRANGEMENTS

2x SEAT ELEMENT 160
+ 5x ARMREST + 3x CUSHION 81

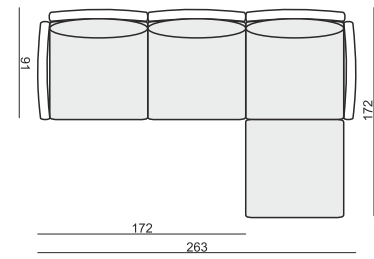

2x SEAT ELEMENT 160 + SEAT ELEMENT 80
+ 5x ARMREST + 3x CUSHION 81

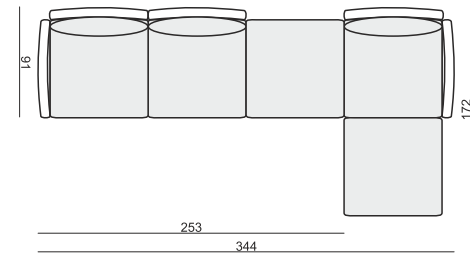

2x SEAT ELEMENT 160 + SEAT ELEMENT 80
+ 8x ARMREST + 5x CUSHION 81 + CUSHION 67

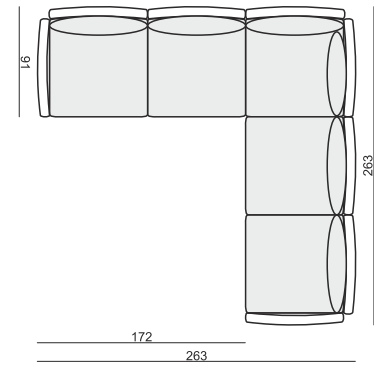

SEAT ELEMENT 160 + 2x SEAT ELEMENT 80
+ 7x ARMREST + 4x CUSHION 81 + CUSHION 67

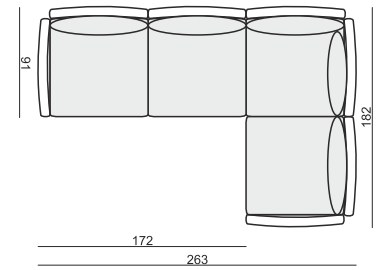

SITS reserves the right to change construction of products and components used due to improving durability of product and customer satisfaction without any further notice. Explicit ±2 cm tolerance of all elements sizes.



UPHOLSTERY

FABRIC: FC - fix cover

FEET

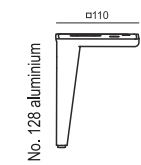
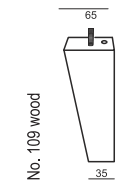

STANDARD COMFORT

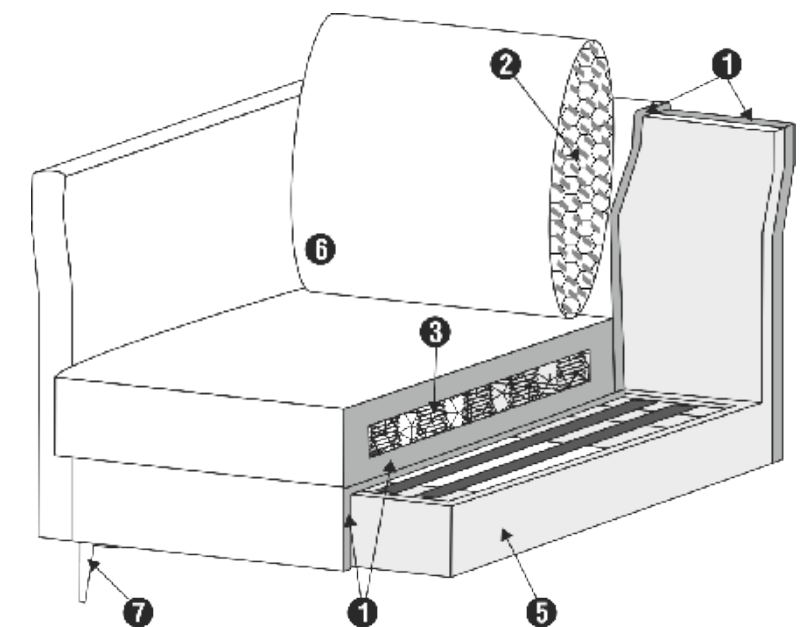

1. polyurethane and laminated foam
2. foam flakes with silicone balls
3. bonnell springs
4. upholstery belts
5. solid wood and wood based elements
6. fabric
7. solid wood/metal legs